

NOTICE D'INSTALLATION

PORTE COULISSANTE

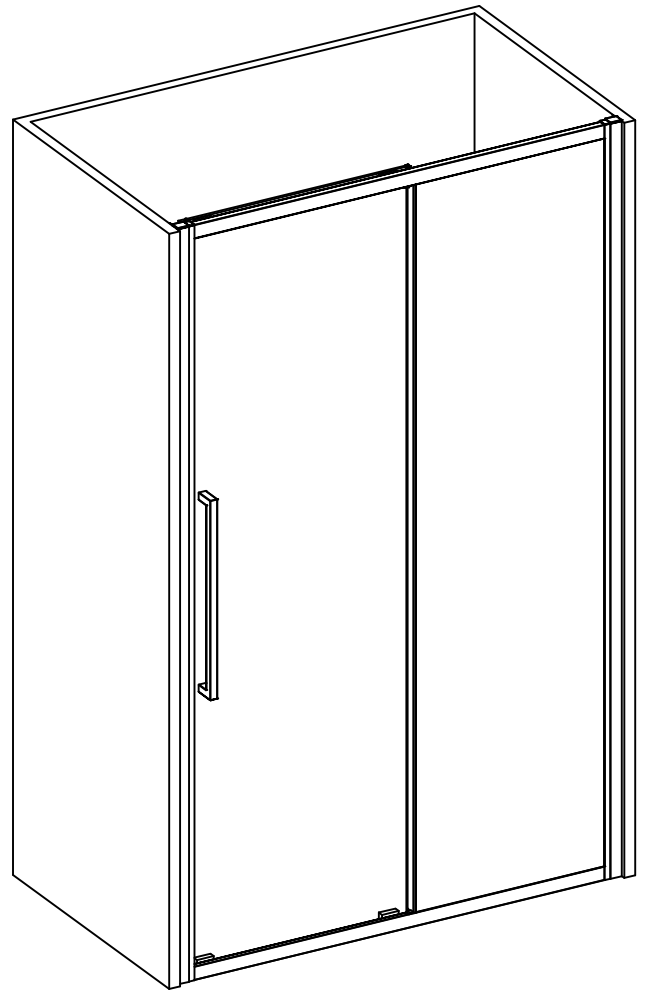

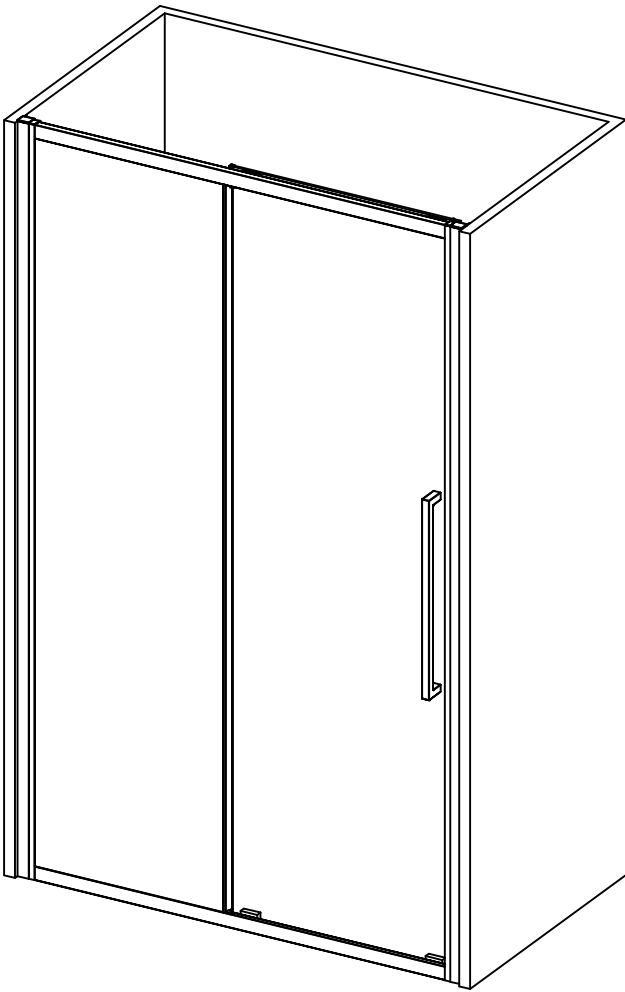
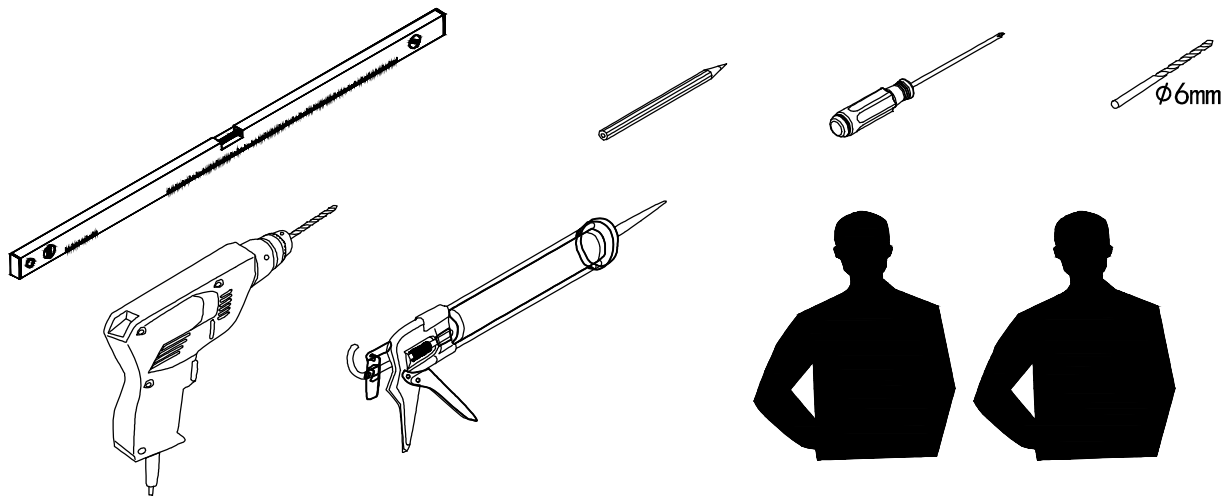

- | | | | | | |
|-----------------|-----------------|-------|-------|------------------|-------|
| ① x 2 | ② x 2 | ③ x 1 | ④ x 2 | ⑤ x 1 | ⑥ x 2 |
| ⑦ x 1 | ⑧ x 2 | ⑨ x 1 | ⑩ x 4 | ⑪ x 10
ST4*10 | ⑫ x 1 |
| ⑬ x 2 | ⑭ x 2 | ⑮ x 1 | ⑯ x 2 | ⑰ x 6 | ⑱ x 2 |
| ⑲ x 8
ST4X30 | ⑳ x 6
ST4X35 | ㉑ x 6 | | | |

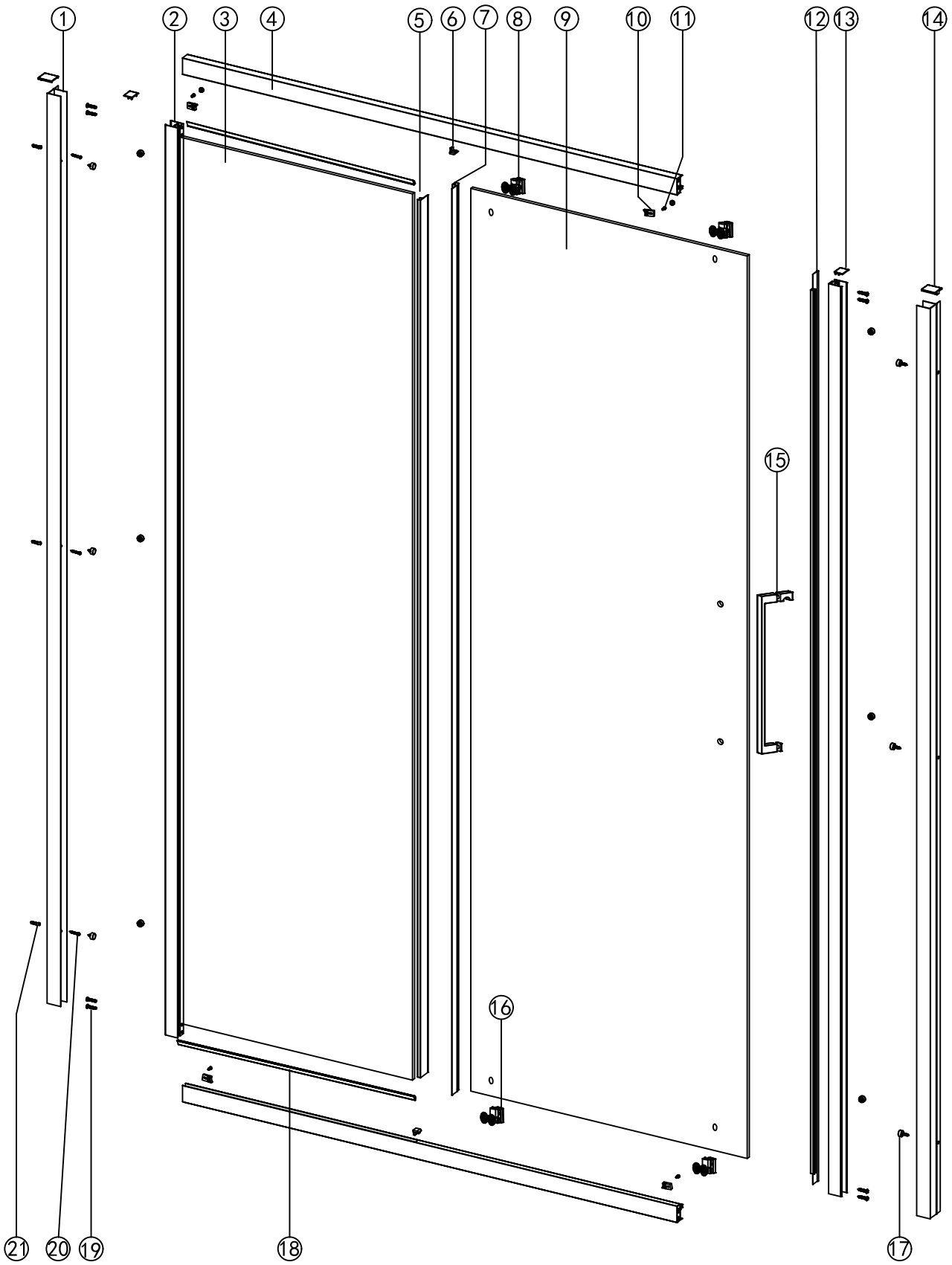

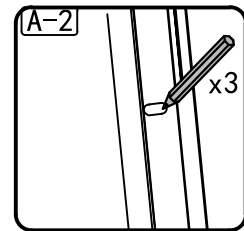
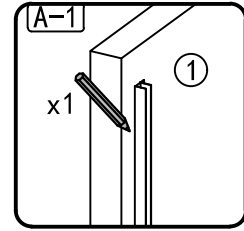
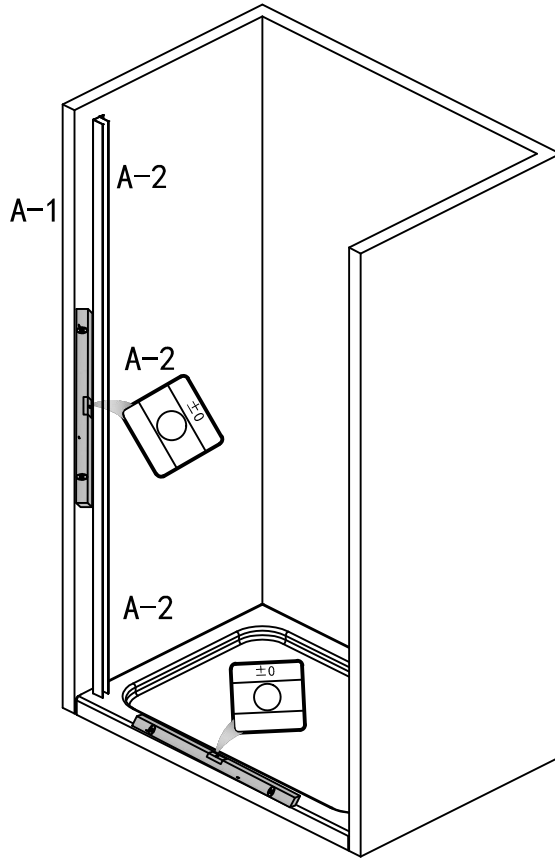
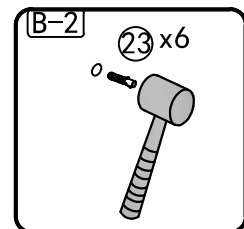
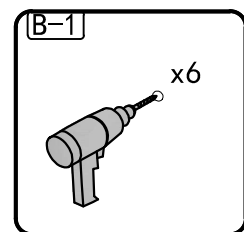
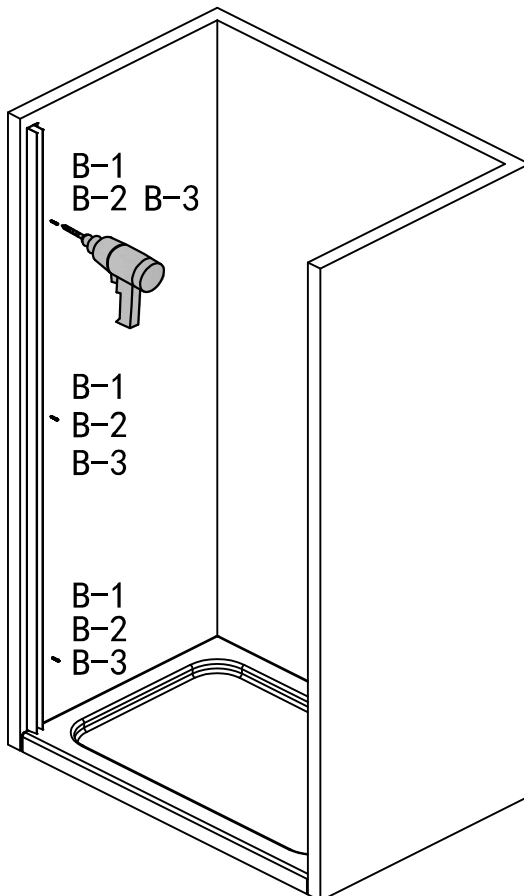
A

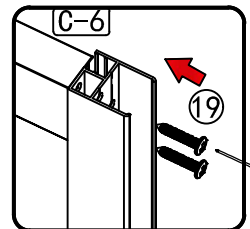
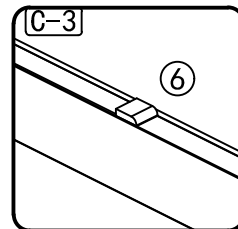
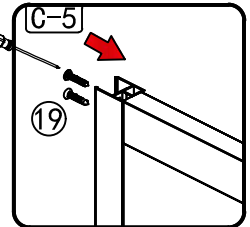
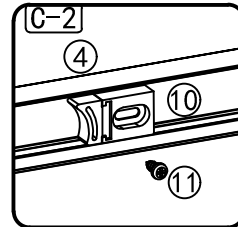
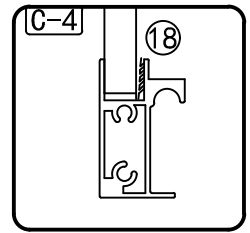
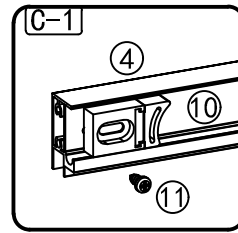
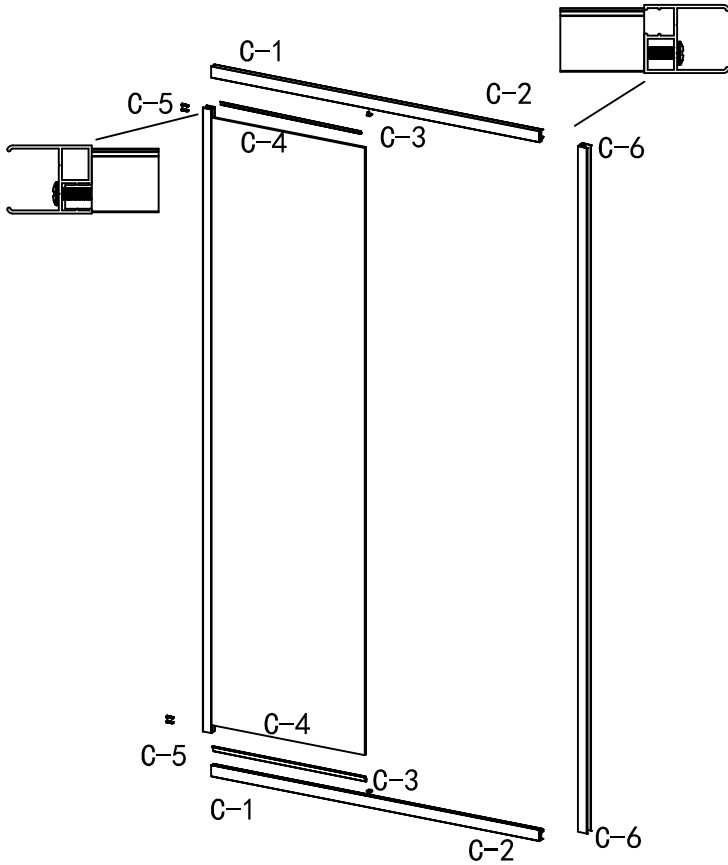
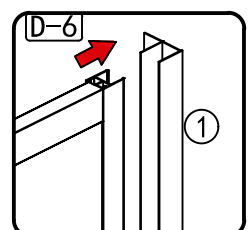
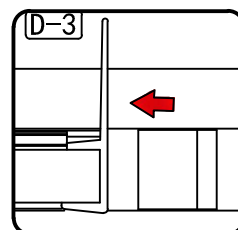
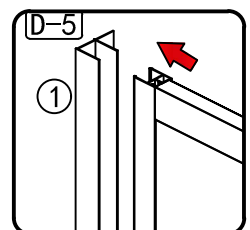
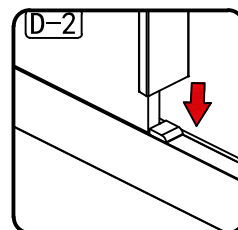
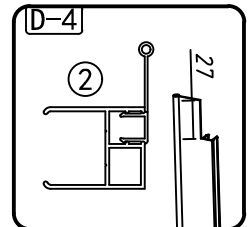
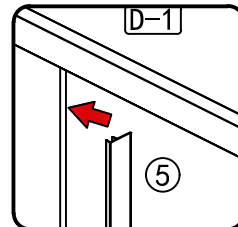
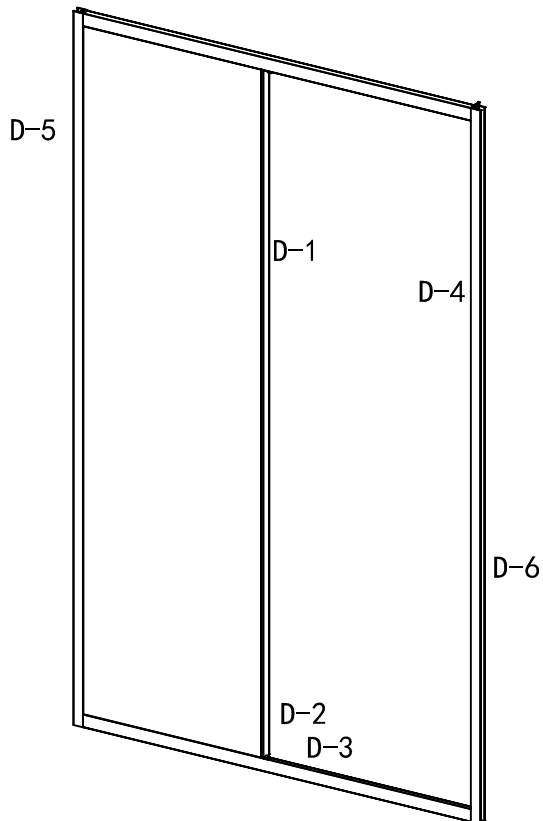
B

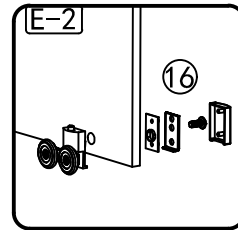
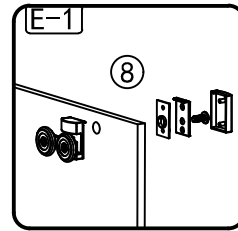
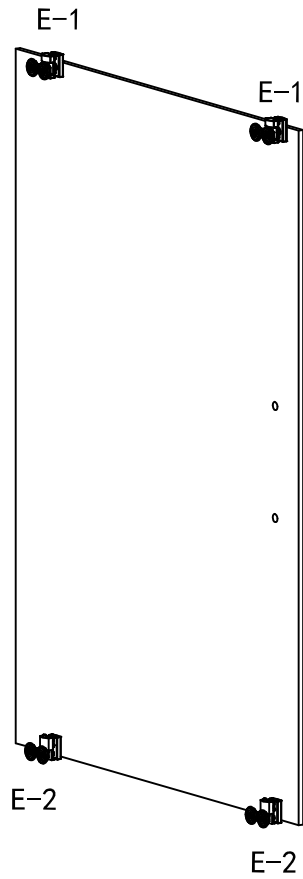
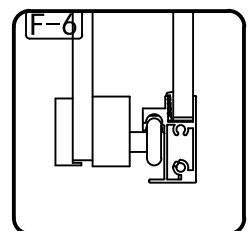
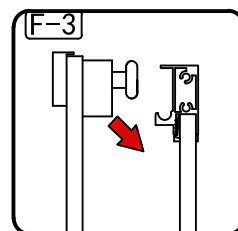
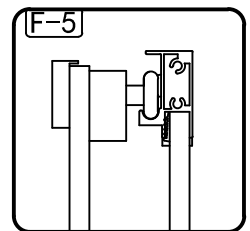
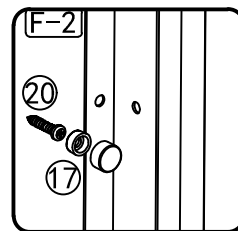
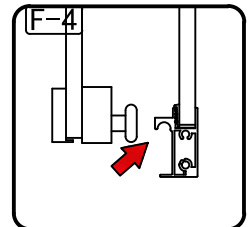
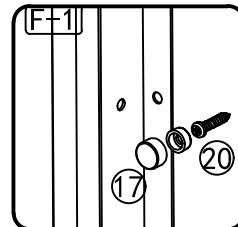
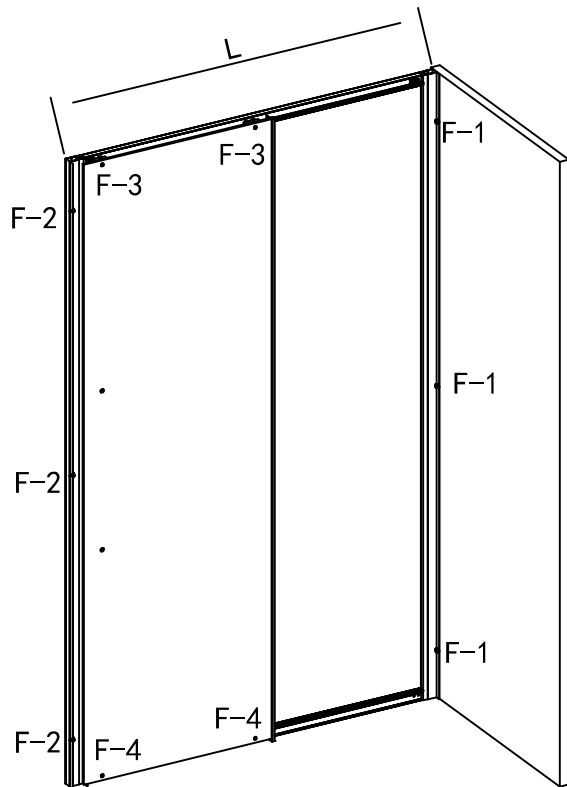
C

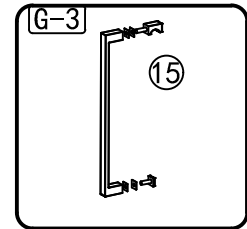
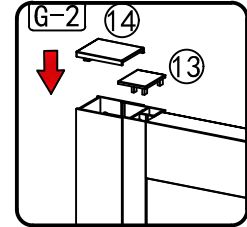
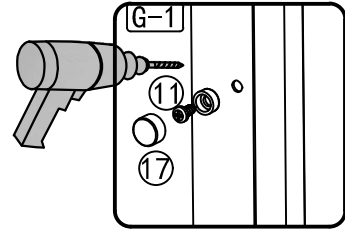
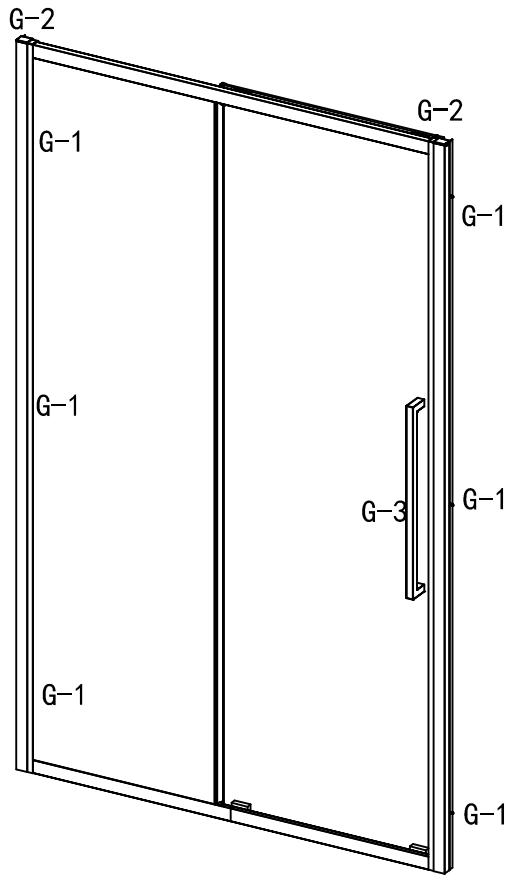
D

E

F

G

H
