

NOTICE D'INSTALLATION

PORTE DE DOUCHE OR

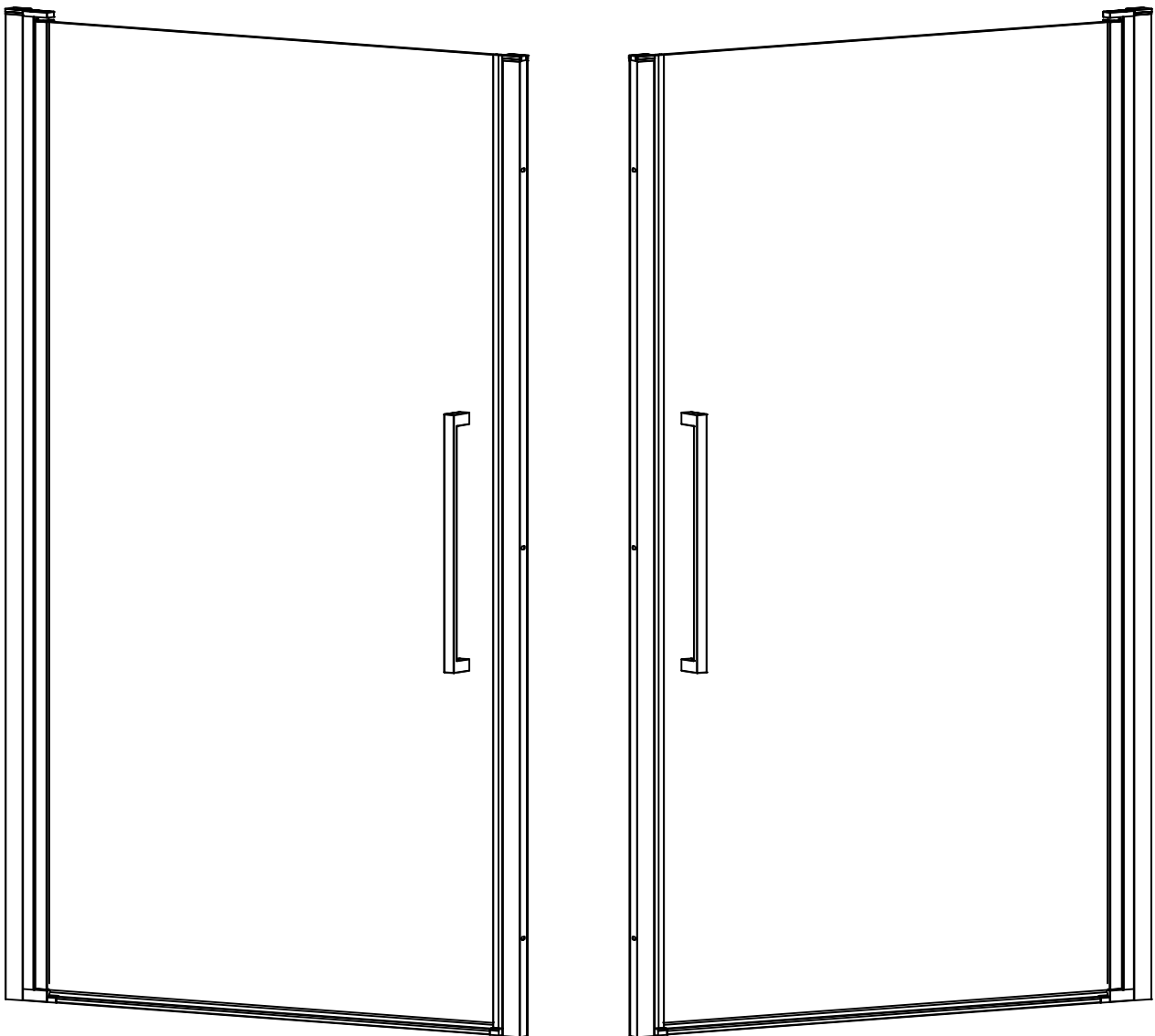

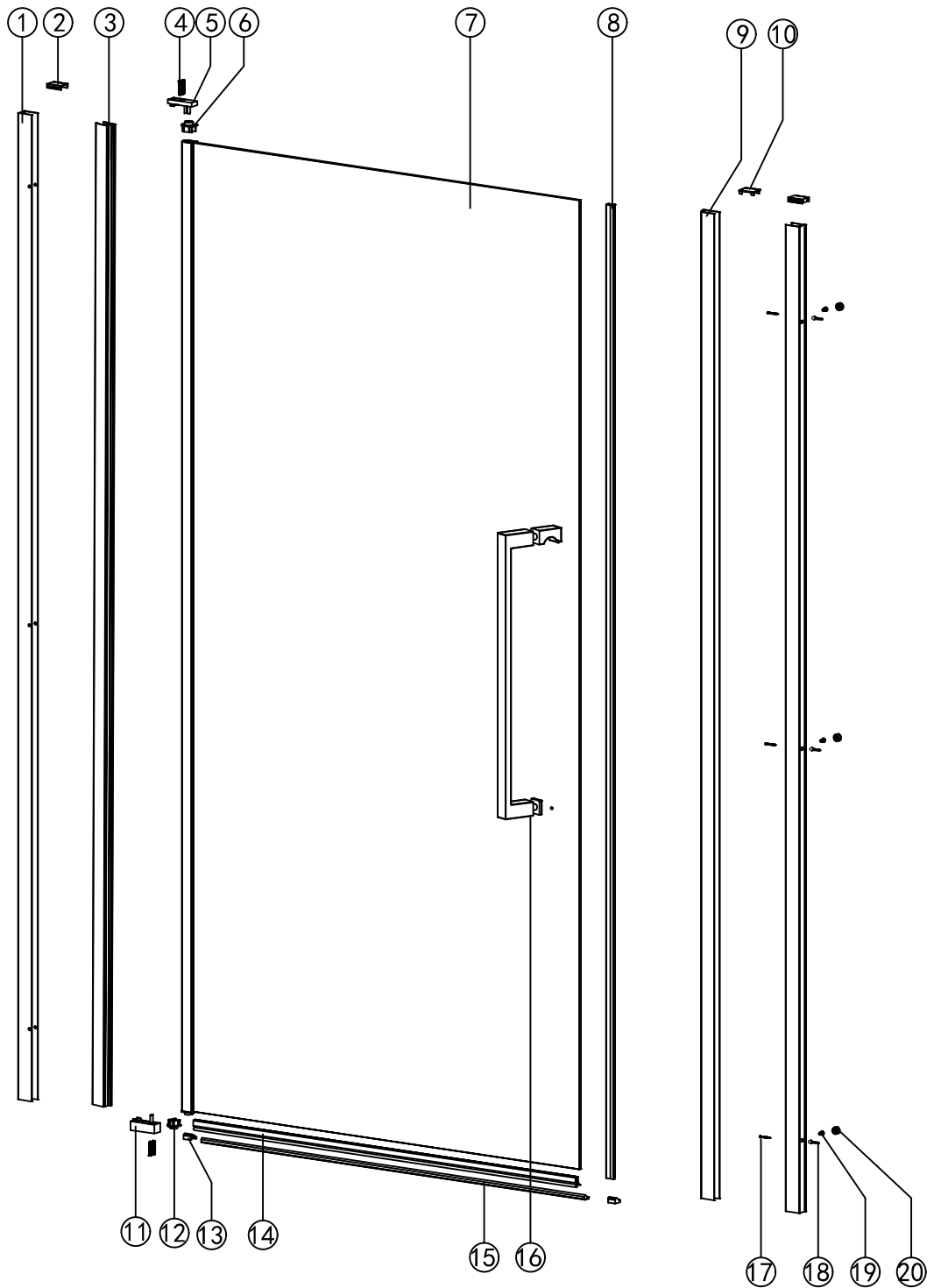

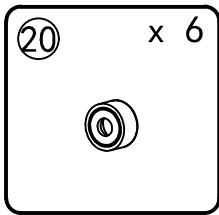
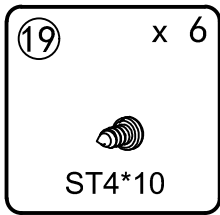
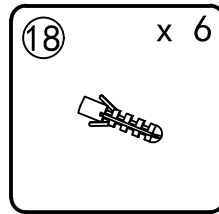
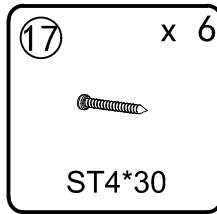
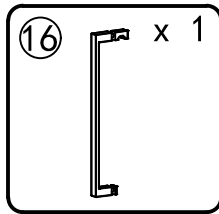
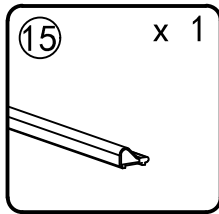
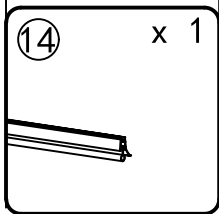
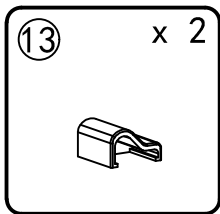
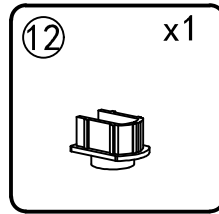
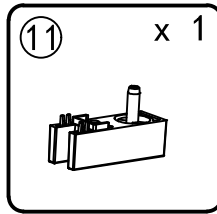
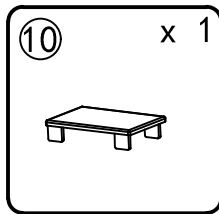
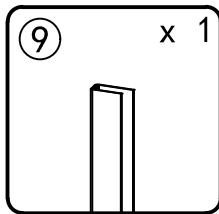
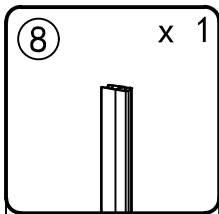
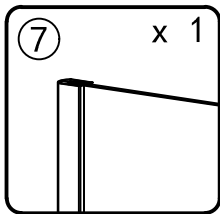
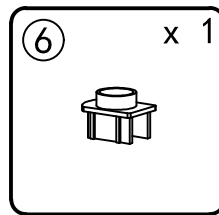
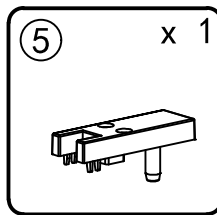
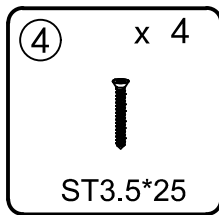
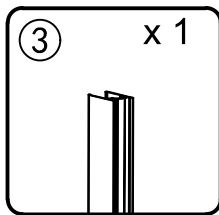
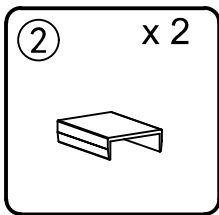
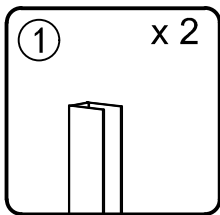
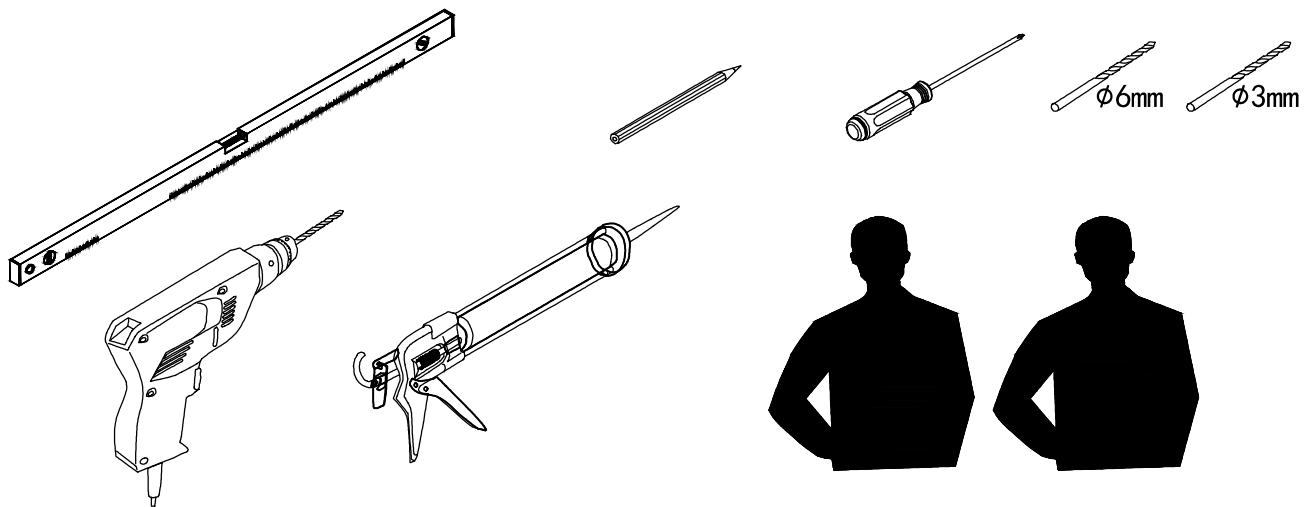

A

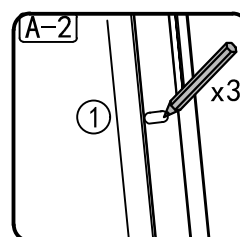
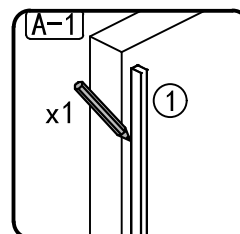
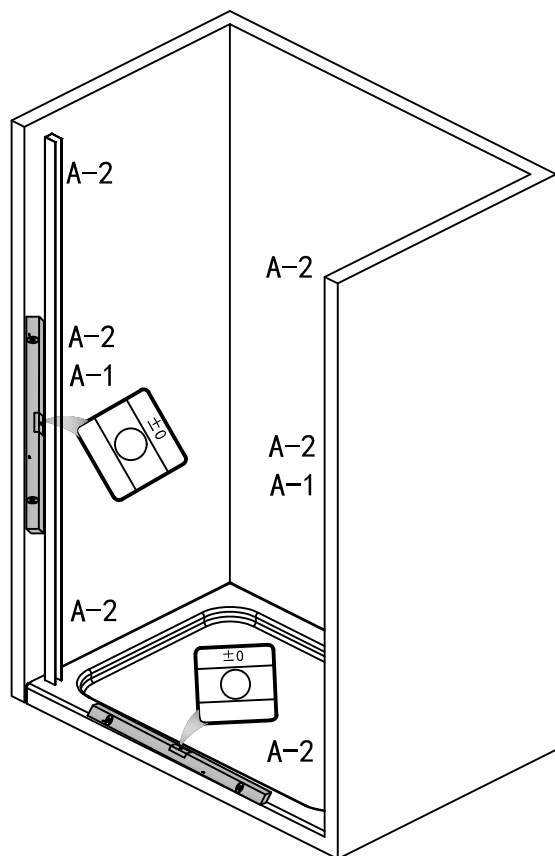

B

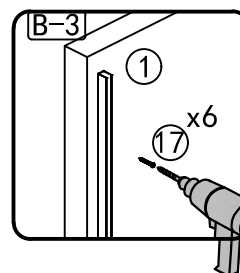
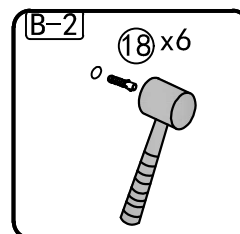
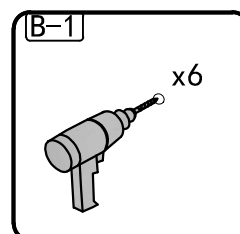
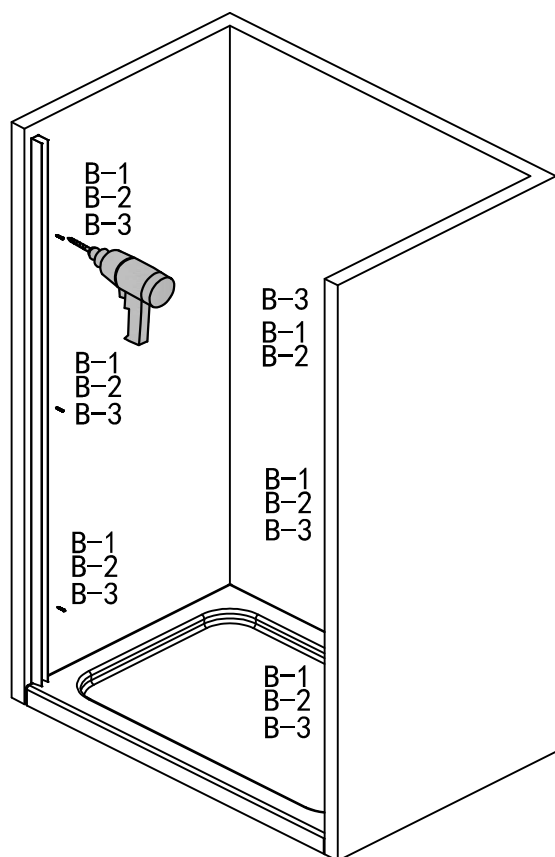

C

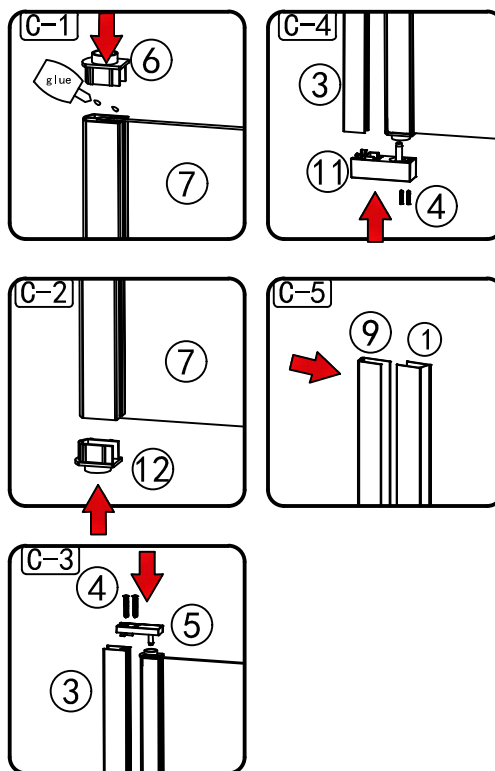
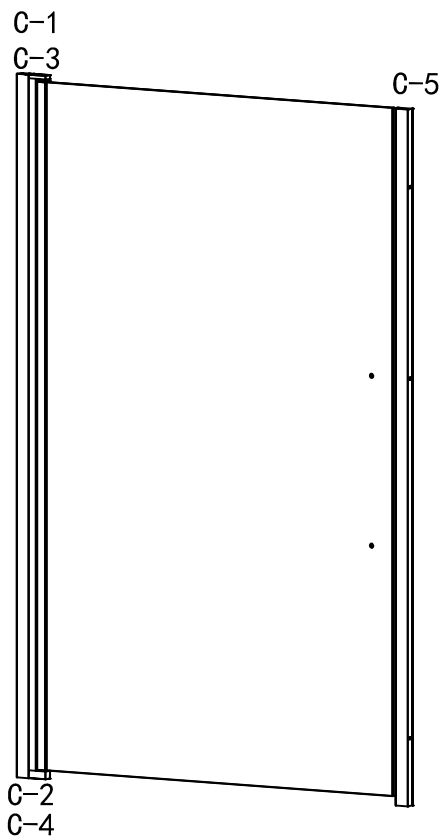

D

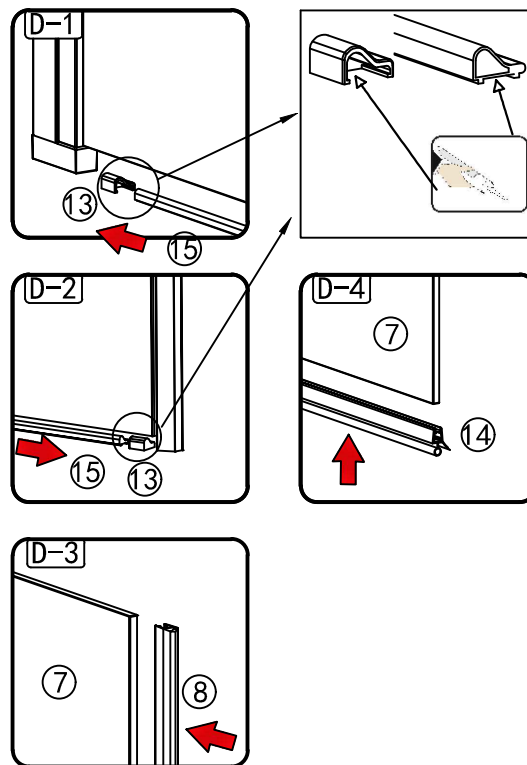
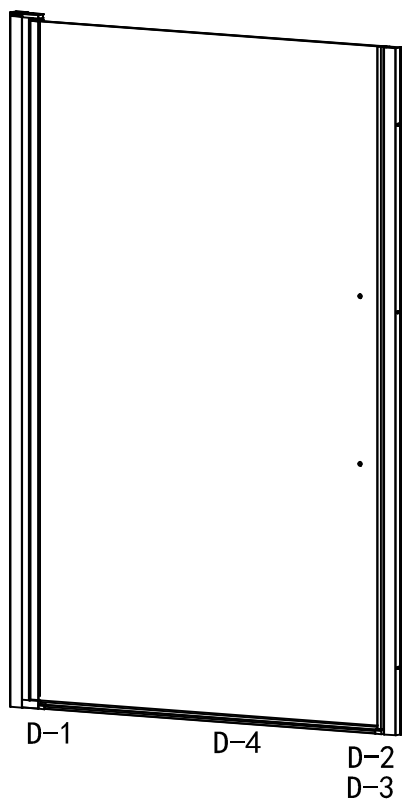

E

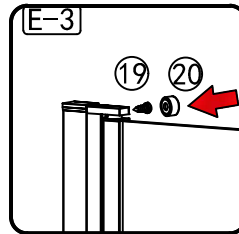
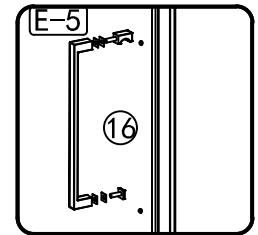
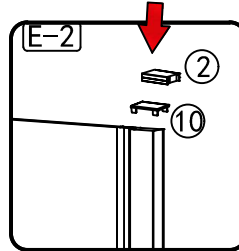
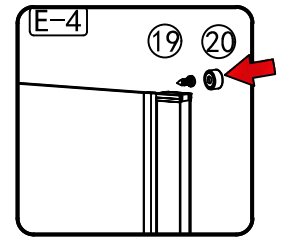
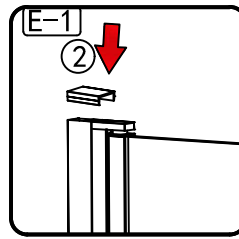
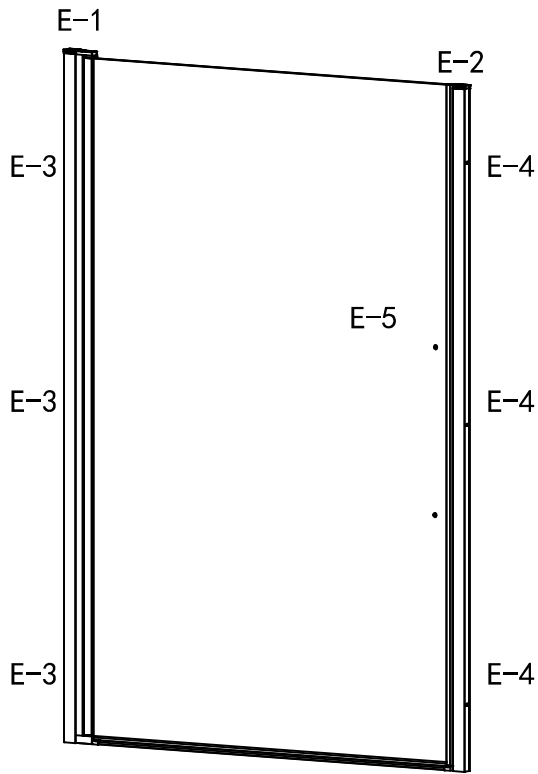

F

