



# TOTS

TOTS Design décline toute responsabilité en cas d'inobservance de ces instructions.  
Any failure to follow these instructions releases TOTS Design from any liability.



1. Rincez les conduites avant l'installation.

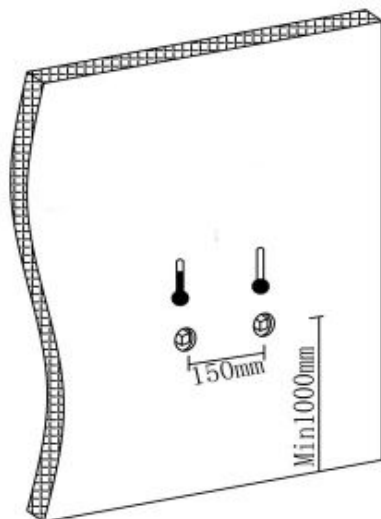

Vérifiez que les deux trous d'arrivée d'eau sur le mur sont parallèles.

Assurez-vous que l'entraxe soit de 150 mm et que la hauteur par rapport au sol soit d'environ 1000-1100 mm.

Dévissez ensuite les écrous d'étanchéité des sorties.

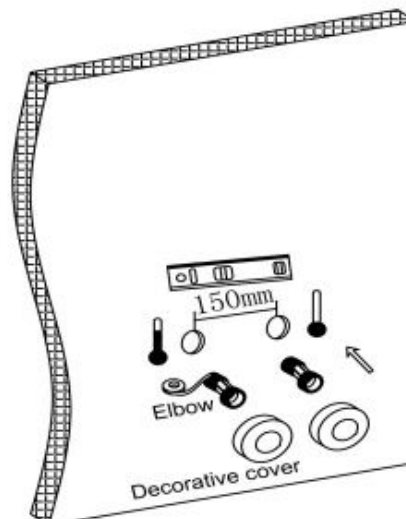

Enroulez le ruban d'étanchéité autour du filetage des coudes et raccordez les à l'arrivée d'eau.

Assurez-vous que les deux coudes sont parallèles et verticaux.

Ensuite, installez les rosaces décoratives.

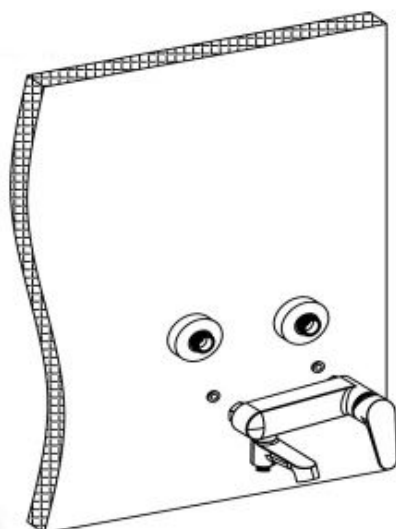

Installez le mitigeur aux coudes.

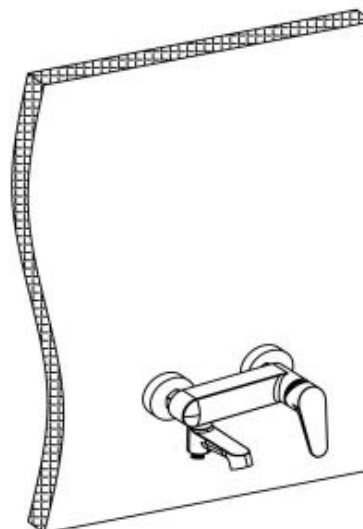

Vérifier qu'il n'y a pas de fuites.

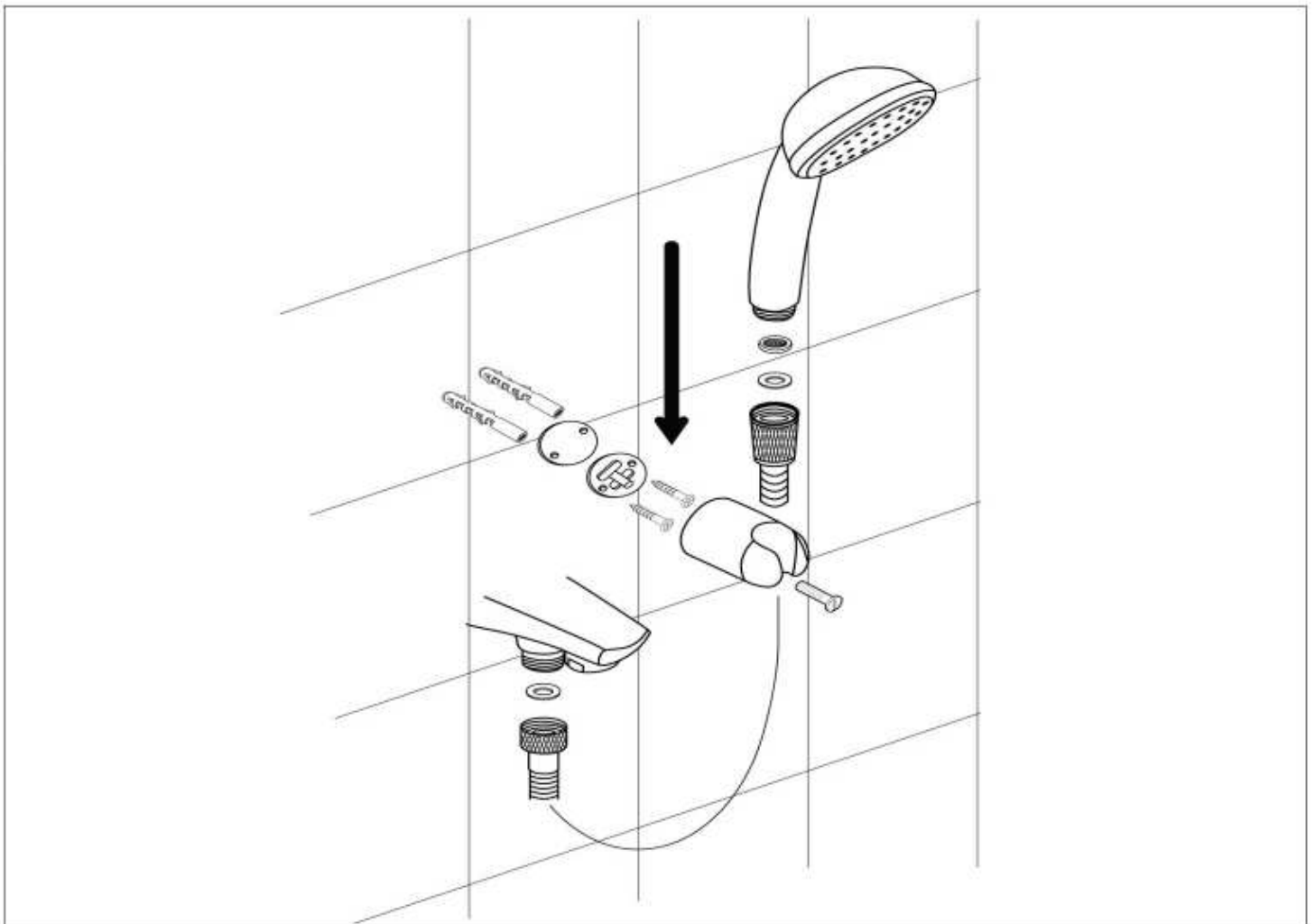
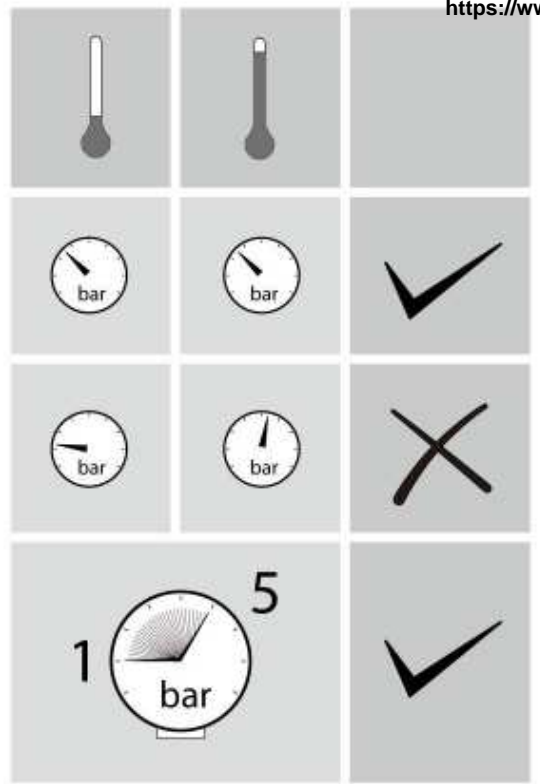
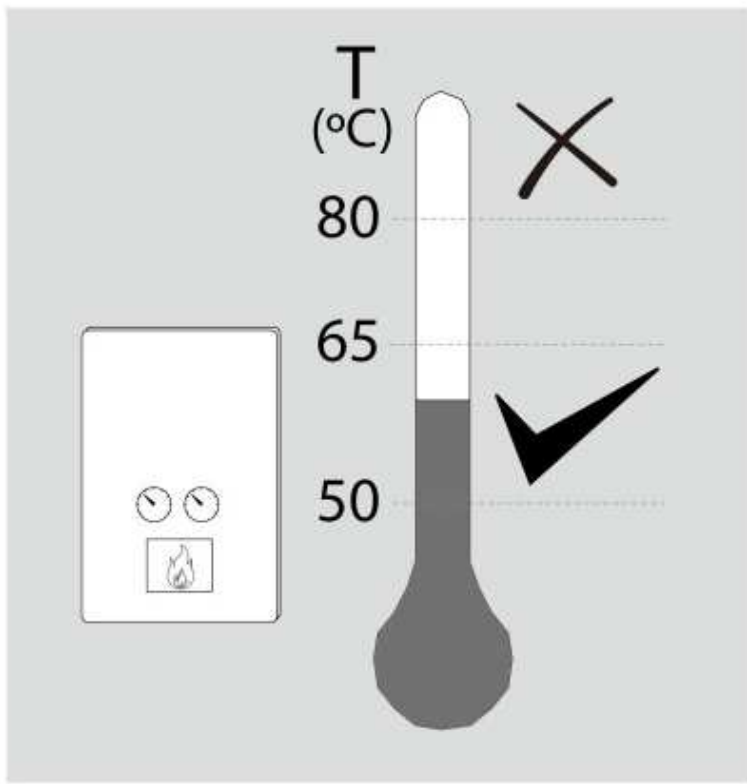

REPLACEMENT DE CARTOUCHE

NETTOYAGE DE L'AÉRATEUR

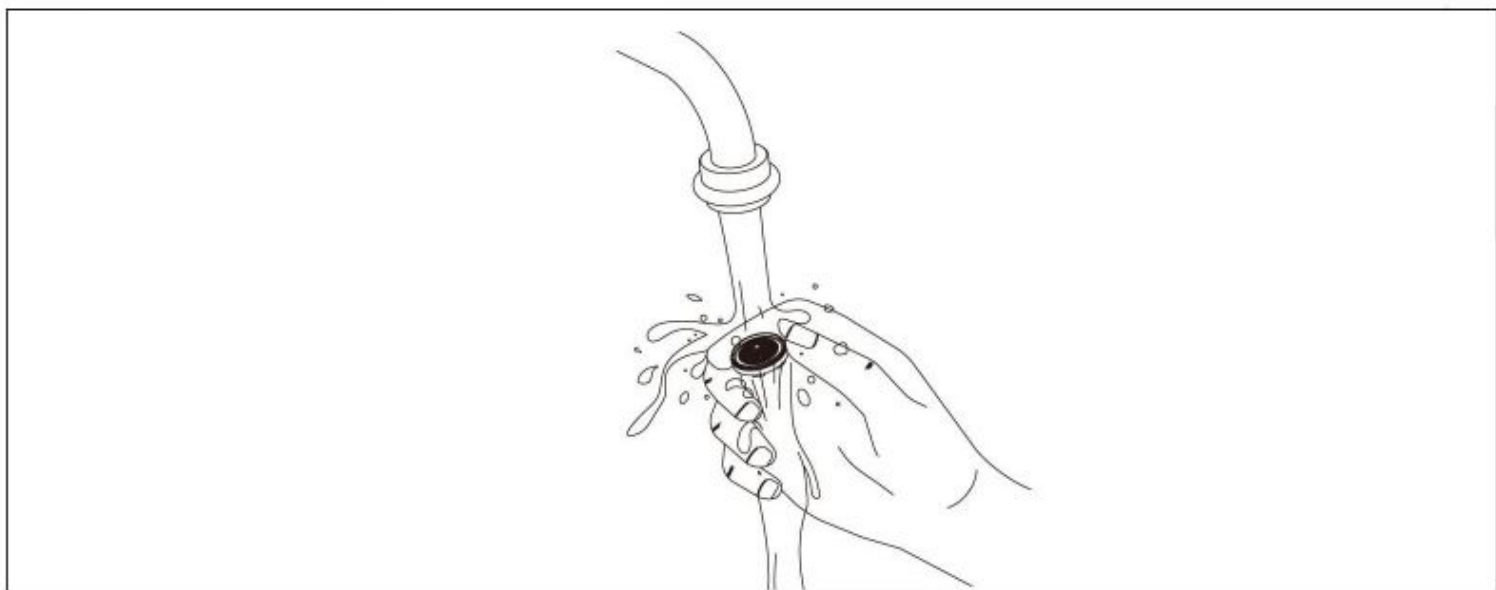
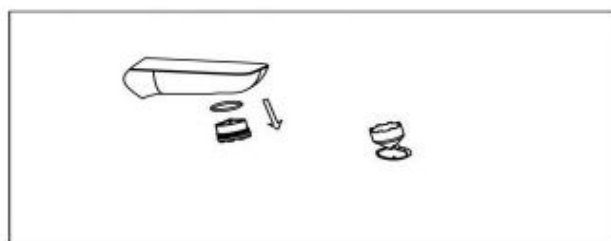
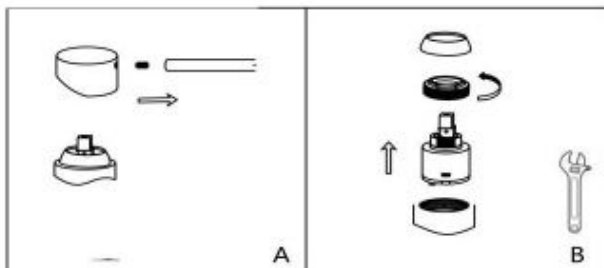
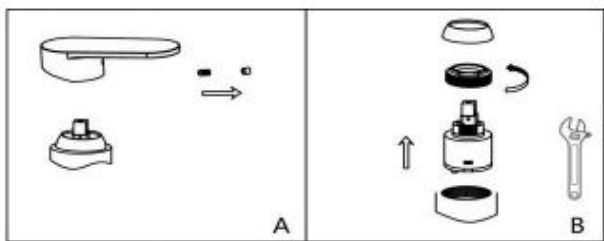

NETTOYAGE · CLEANING

