

# Notice d'installation

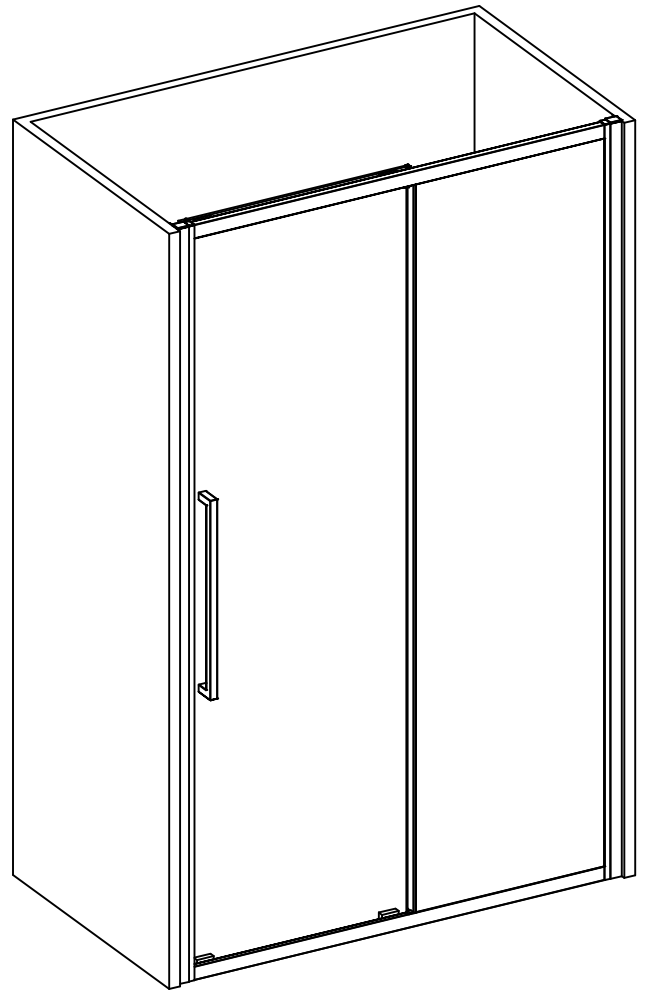

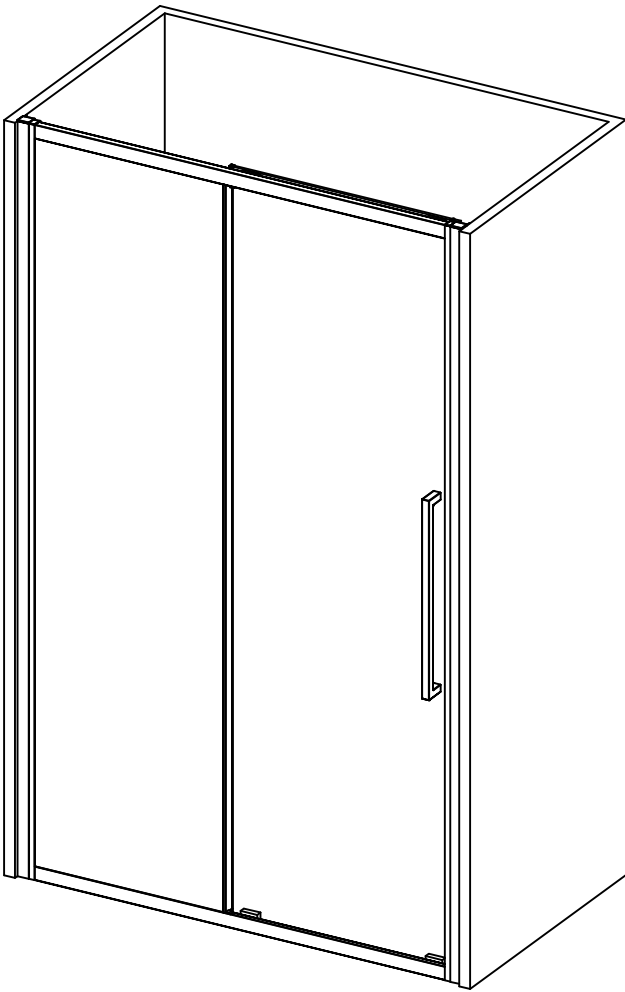

- |                 |                 |       |       |                  |       |
|-----------------|-----------------|-------|-------|------------------|-------|
| ① x 2           | ② x 2           | ③ x 1 | ④ x 2 | ⑤ x 1            | ⑥ x 2 |
| ⑦ x 1           | ⑧ x 2           | ⑨ x 1 | ⑩ x 4 | ⑪ x 10<br>ST4*10 | ⑫ x 1 |
| ⑬ x 2           | ⑭ x 2           | ⑮ x 1 | ⑯ x 2 | ⑰ x 6            | ⑱ x 2 |
| ⑲ x 8<br>ST4X30 | ⑳ x 6<br>ST4X35 | ㉑ x 6 |       |                  |       |

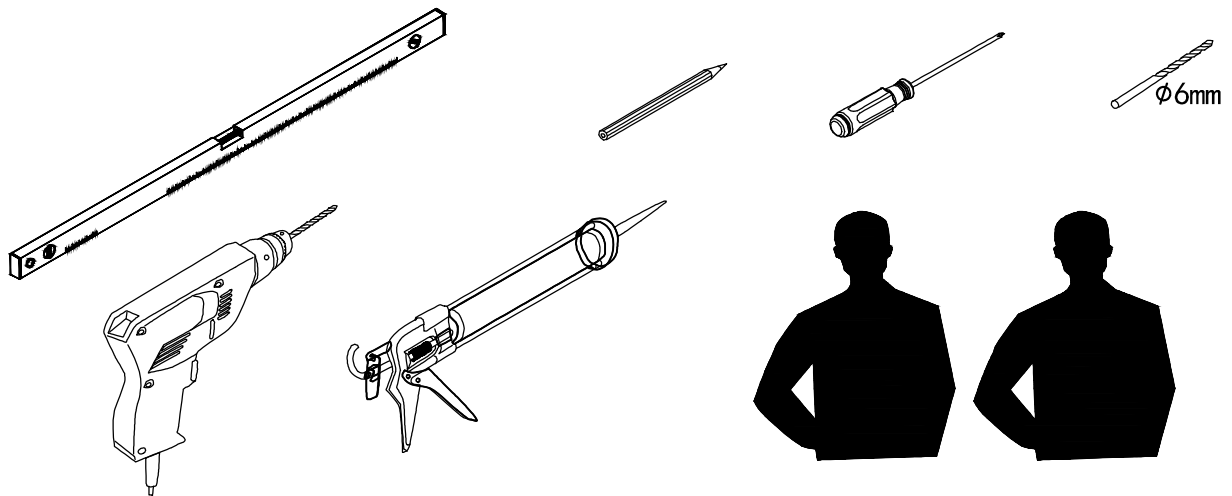
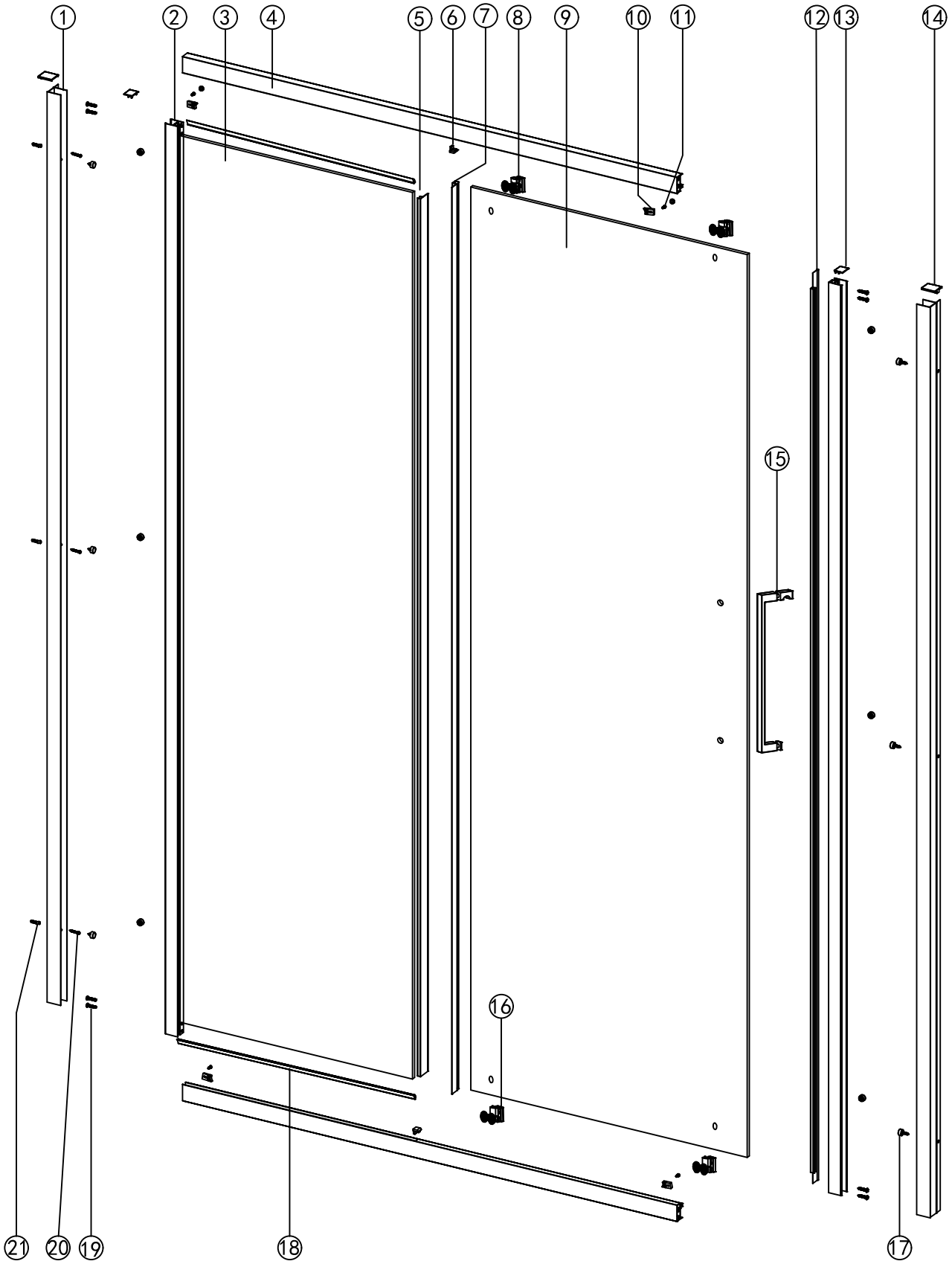

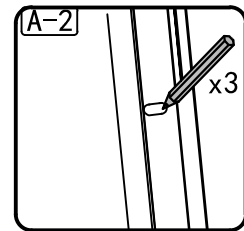
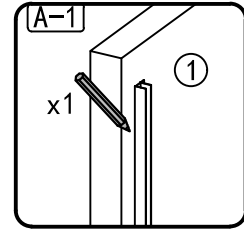
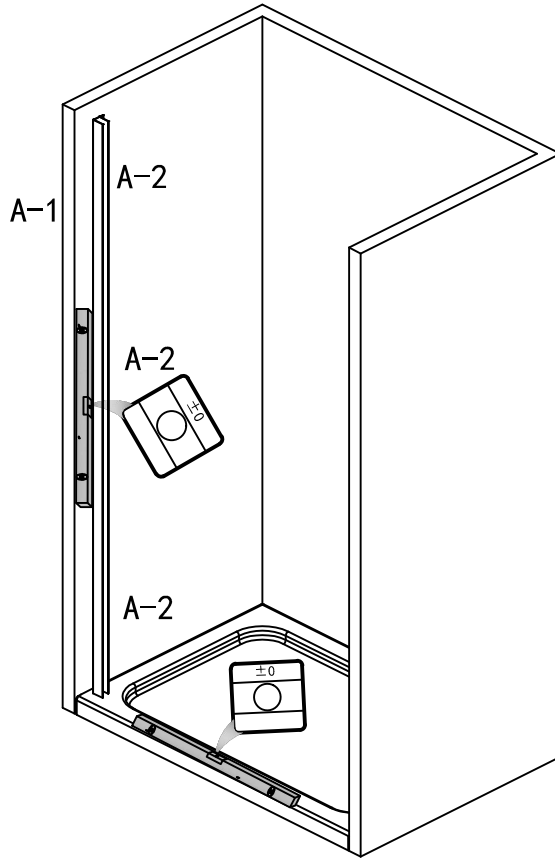
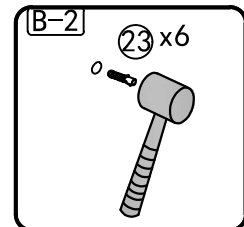
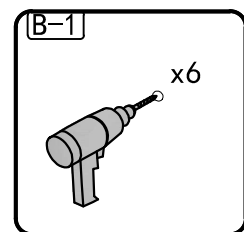
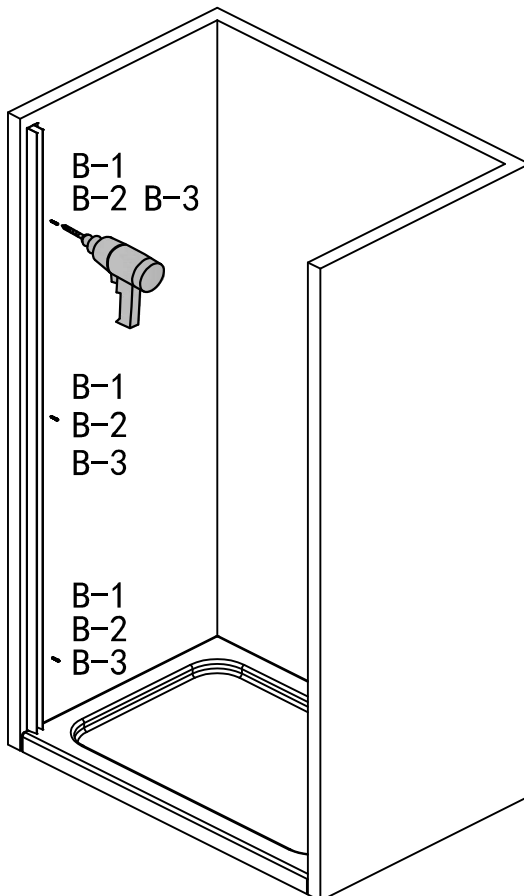
**A**

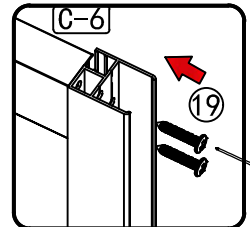
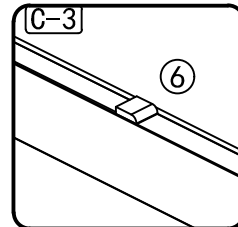
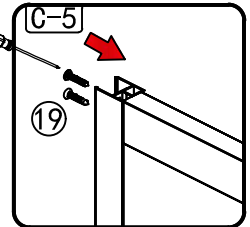
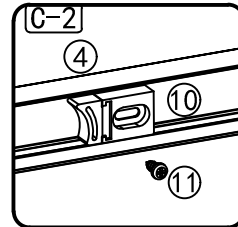
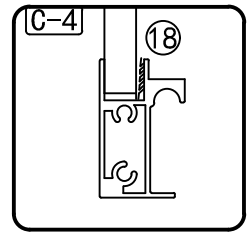
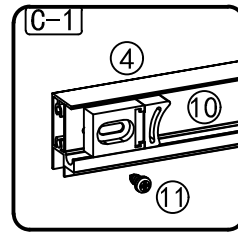
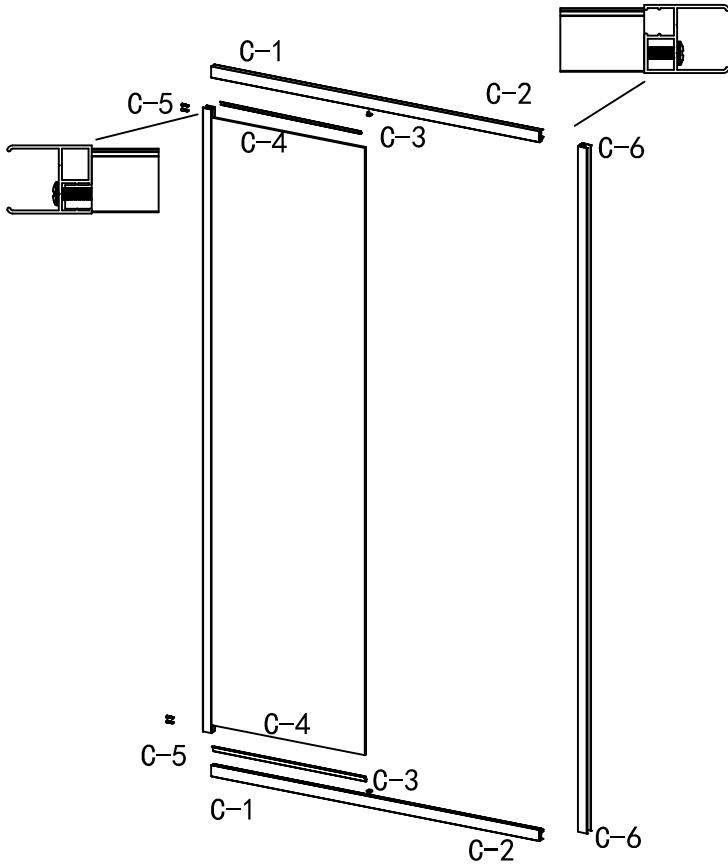
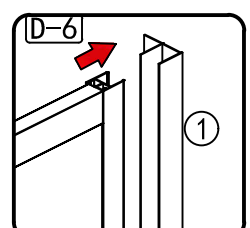
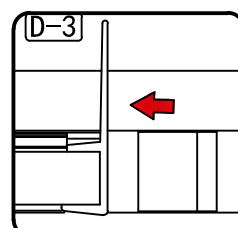
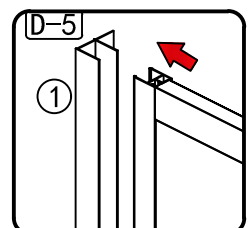
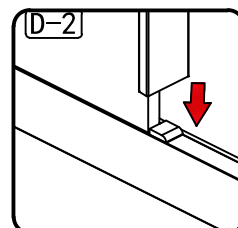
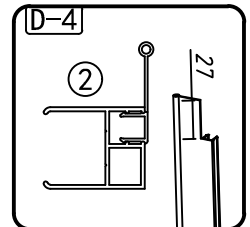
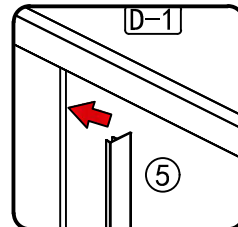
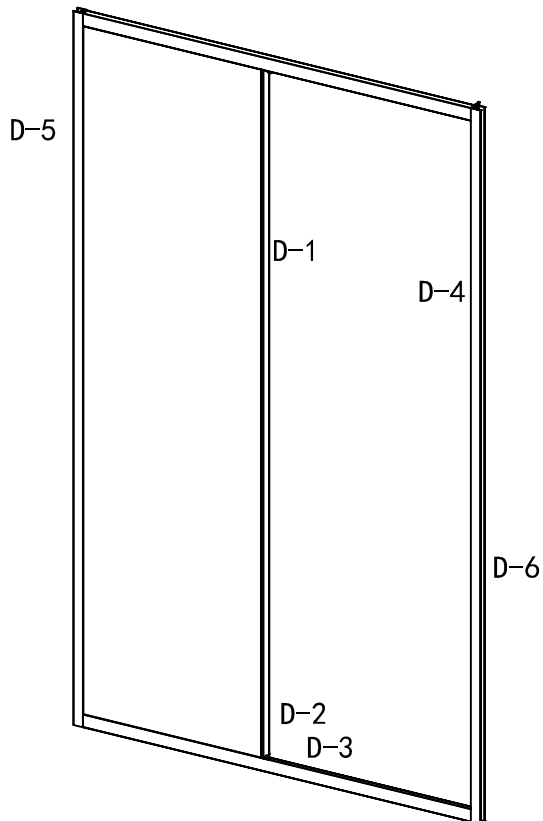
**B**

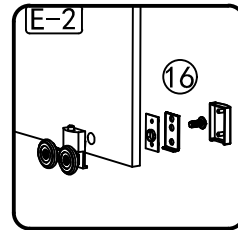
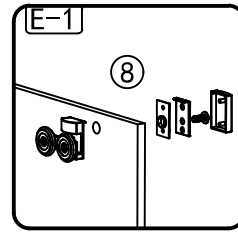
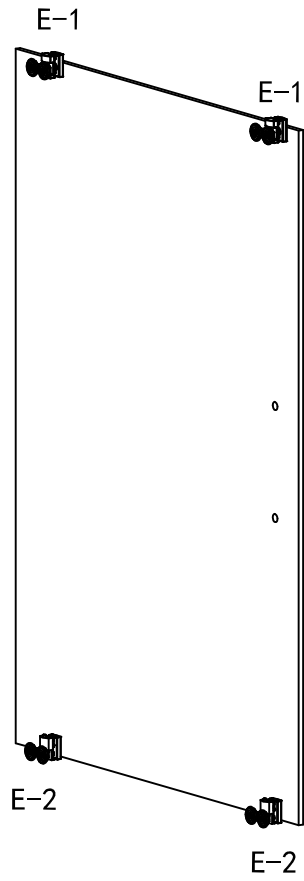
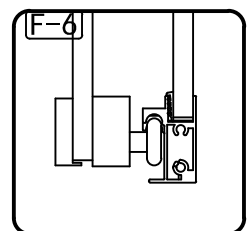
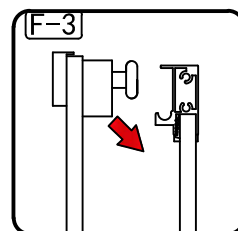
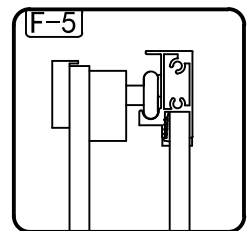
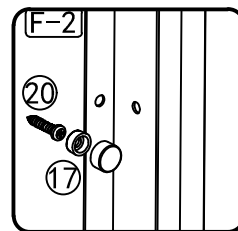
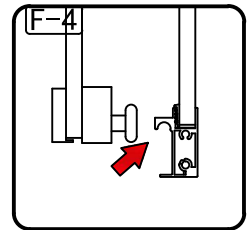
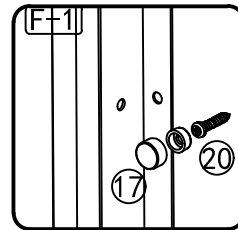
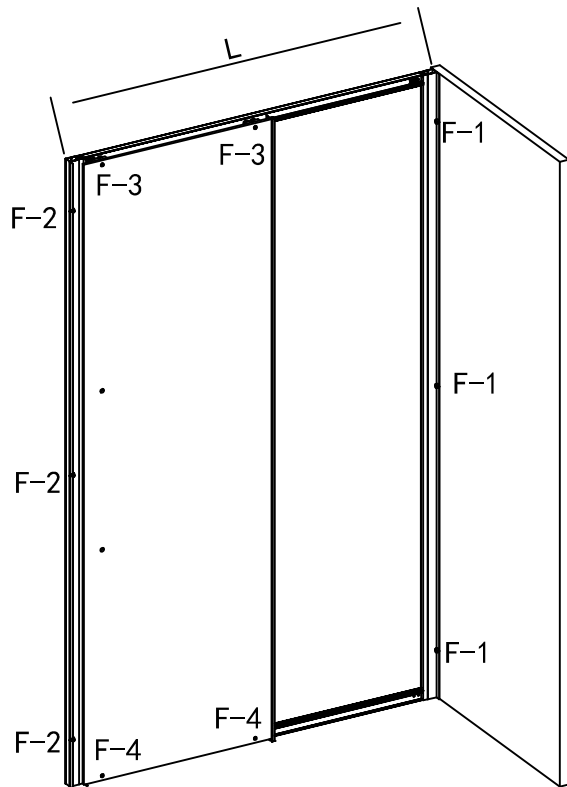
**C**

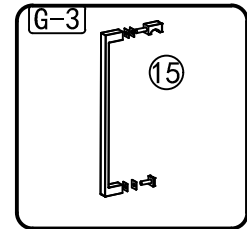
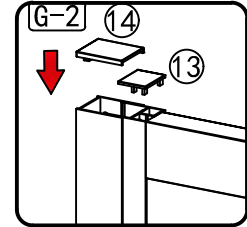
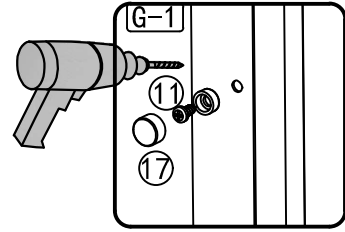
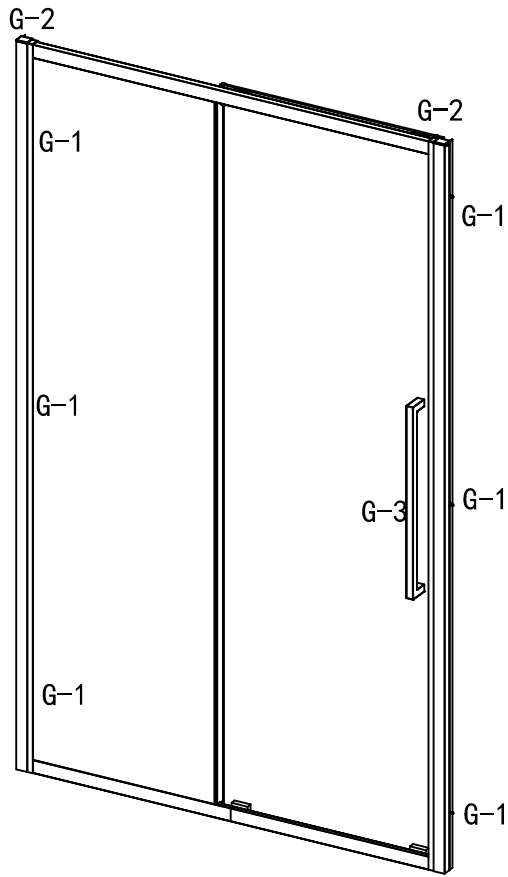
**D**

**E**

**F**

**G**

**H**
