

Notice d'installation

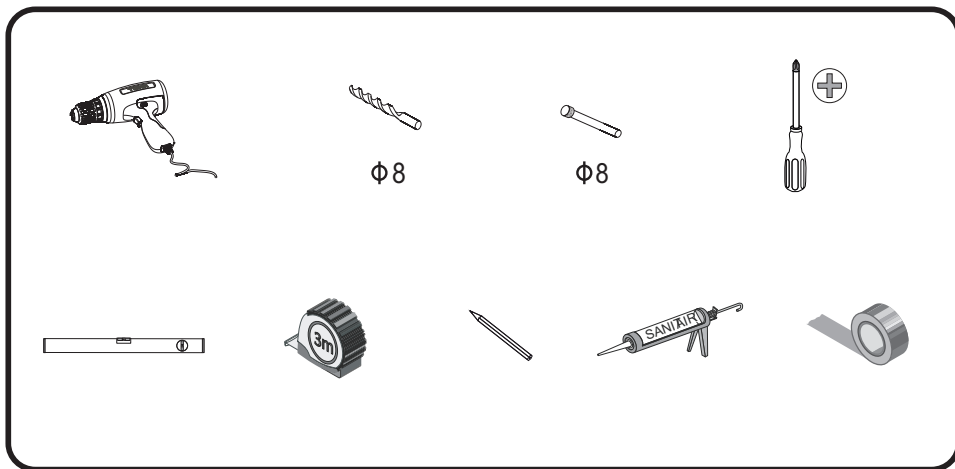

1 - Liste des pièces	01
2 - Instructions d'installation	03
3 - Instructions d'installation	08
4 - Installation et réglage du tiroir	09
5 - Démonter un tiroir	10

Liste des outils



Liste des pièces

Système de fixation 2

Meuble

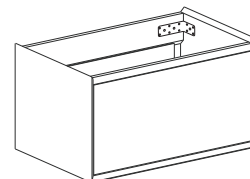

Plan vasque

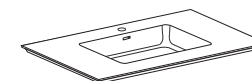

Pièces de fixation

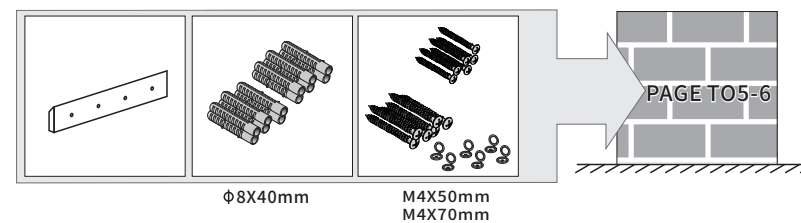

Système de fixation 1

Meuble

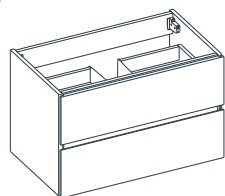

Plan vasque

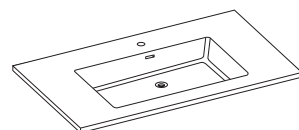

Pièces de fixation

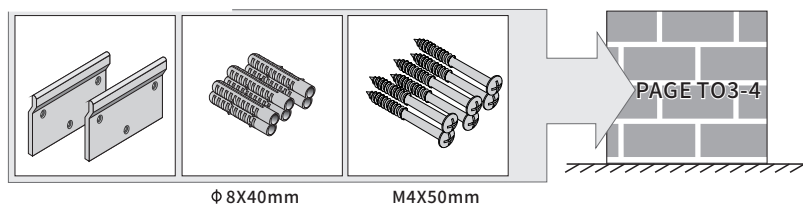

Système de fixation 3

Meuble

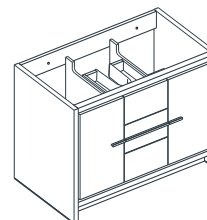

Plan vasque

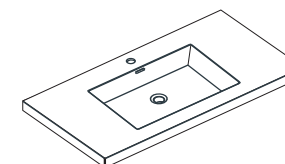

Pièces de fixation

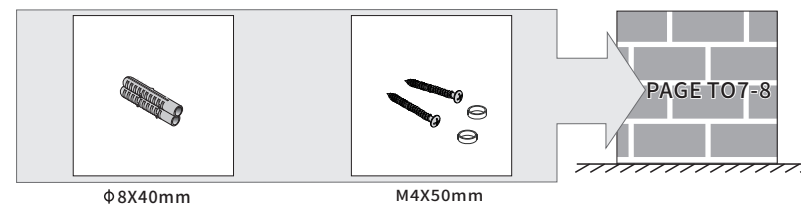

Instructions d'installation

Système de fixation 1

<p>1</p>	<p>2</p> <p> tiroir en metal</p>
<p>2</p> <p> tiroir en bois</p>	<p>3</p> <p> tiroir en metal</p>
<p>3</p> <p> tiroir en bois</p>	<p>4</p>

<p>5</p> <p>2mm 2mm 850mm</p>	
<p>6</p>	<p>7</p>
<p>8</p>	<p>9</p>

Instructions d'installation

Système de fixation 2

<p>1</p>	<p>2</p> <p>tiroir en metal</p>
<p>2</p> <p>tiroir en bois</p>	<p>3</p> <p>tiroir en metal</p>
<p>3</p> <p>tiroir en bois</p>	<p>4</p>

<p>1</p> <p>hauteur d'installation recommandée</p>	
<p>2</p> <p>635mm</p>	
<p>3</p> <p>Mur</p> <p>Mur</p>	<p>4</p>

Instructions d'installation

Système de fixation 3

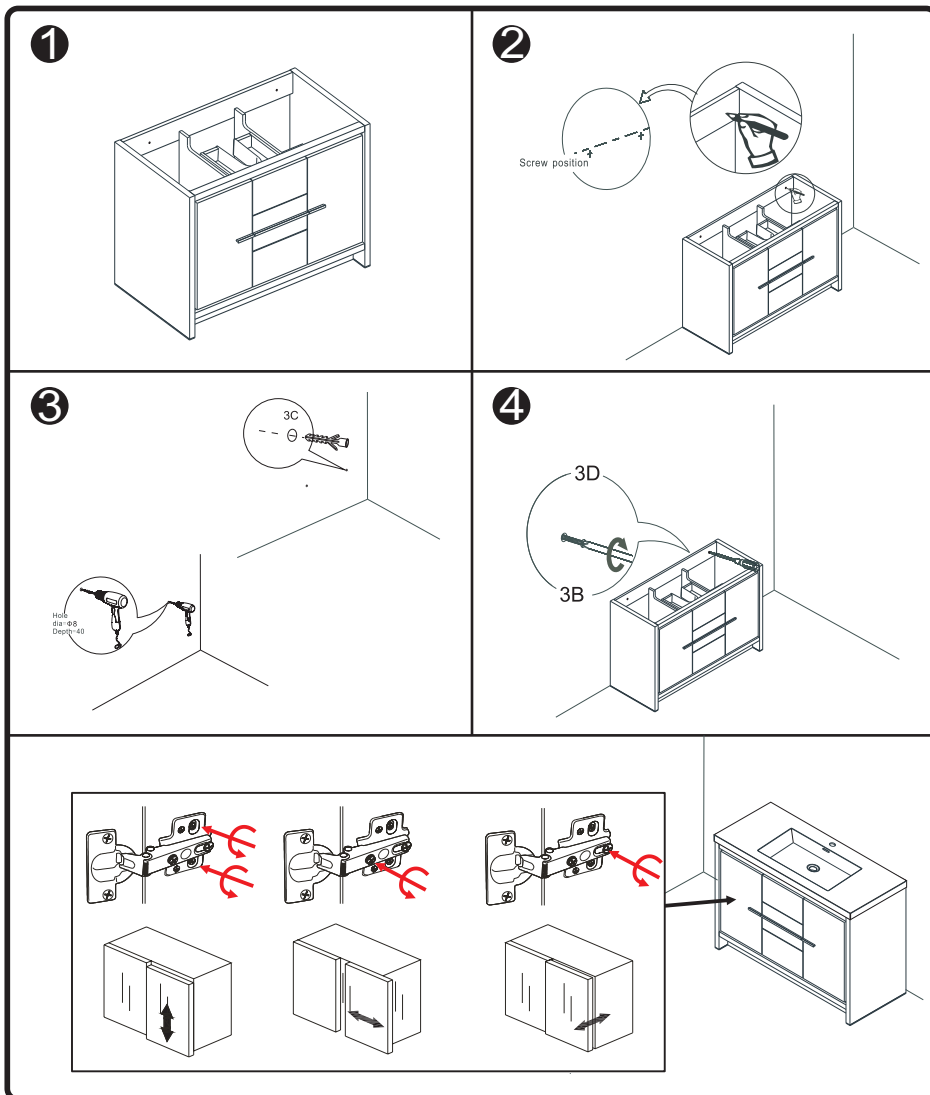

Instructions d'installation

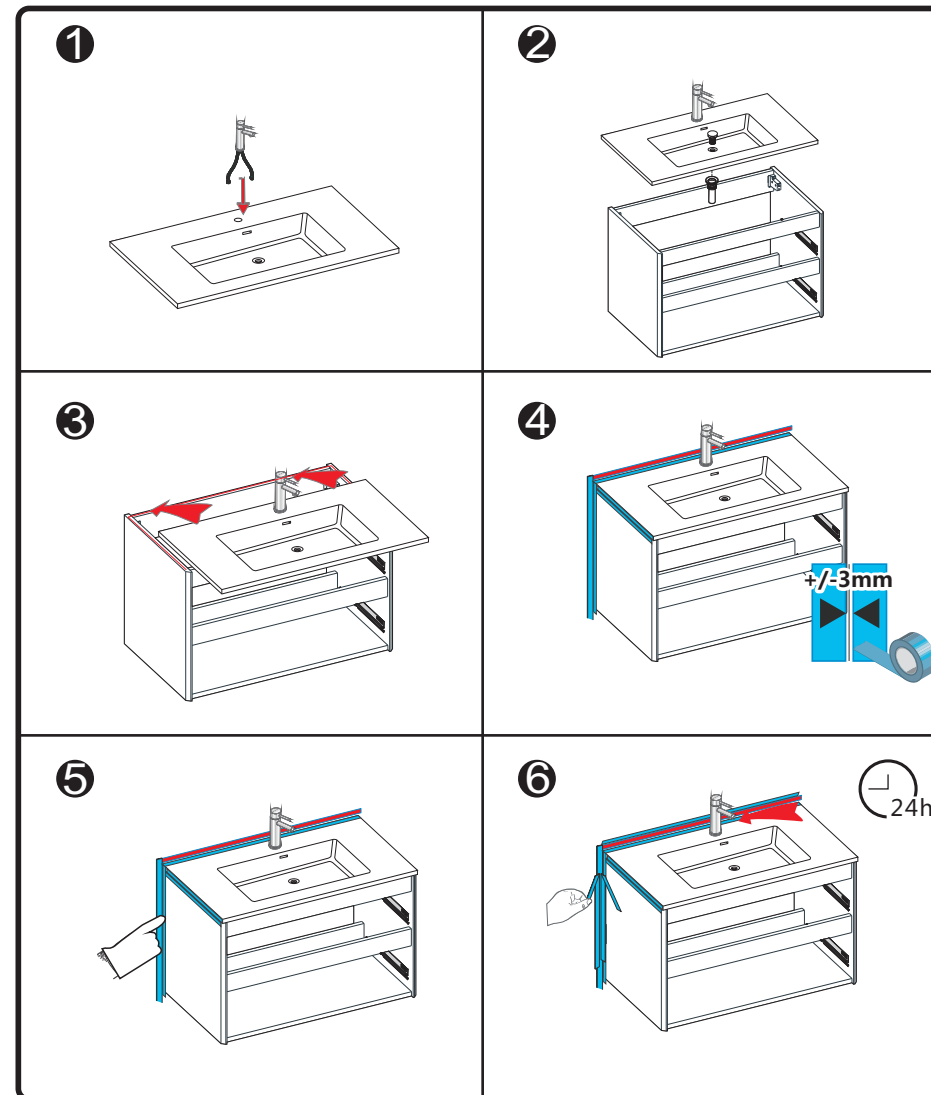

Installation et réglage du tiroir

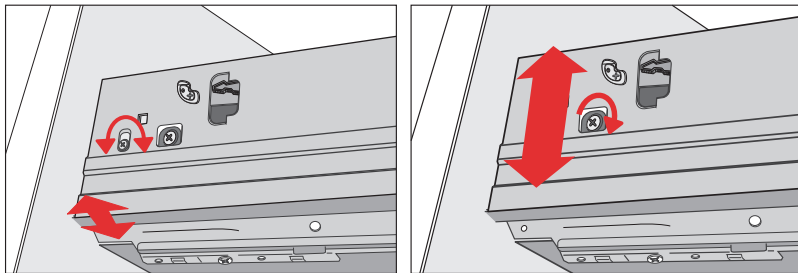
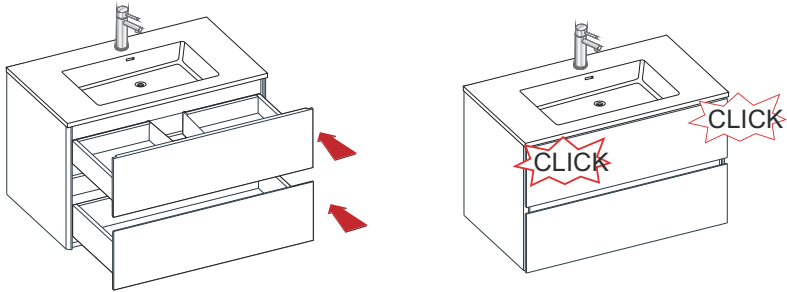

tiroir en métal

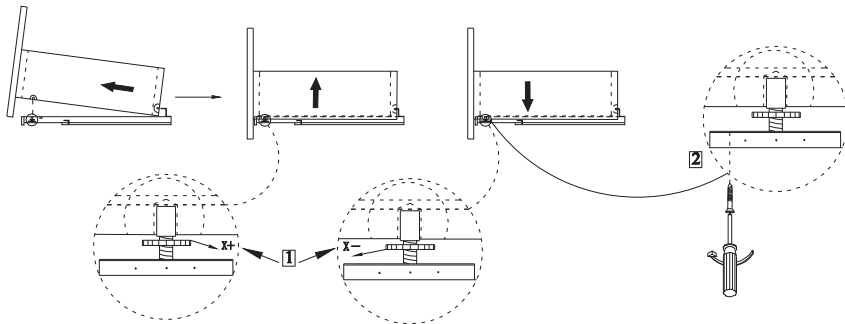

tiroir en bois

Désinstaller un tiroir

1

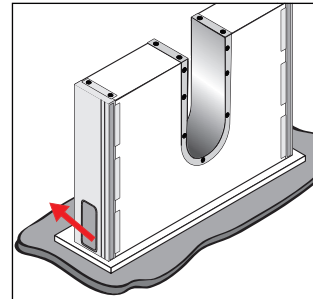

2

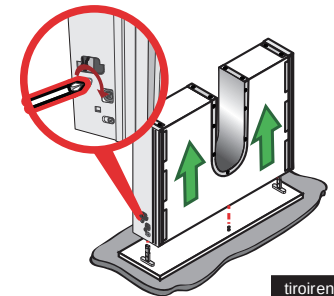

tiroir en métal

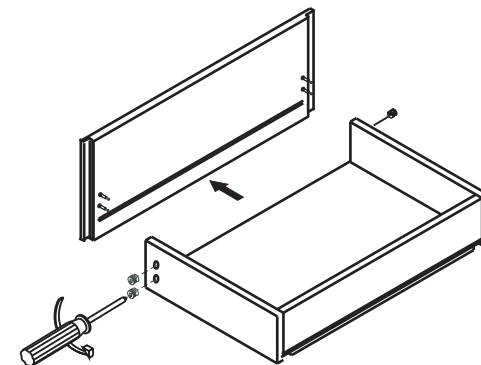

tiroir en bois