

Notice d'installation

Bathtub Faucet

Outils

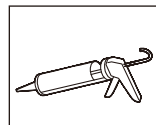
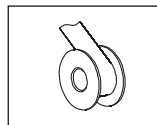
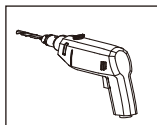
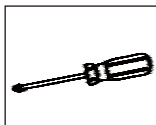
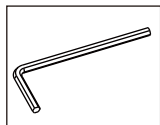
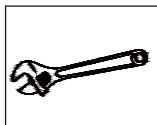

Étapes d'installation

1

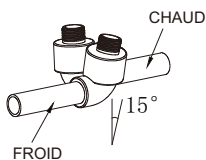

2

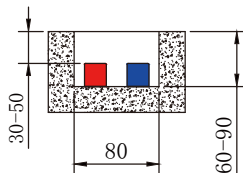

3

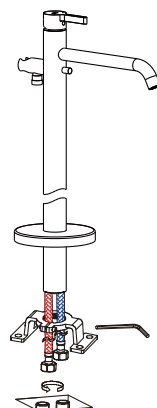

4

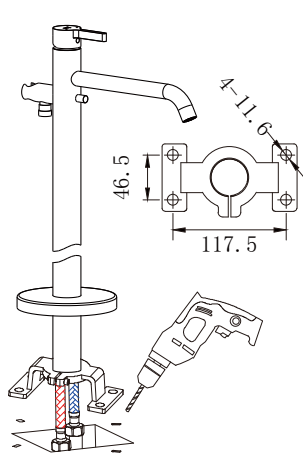

5

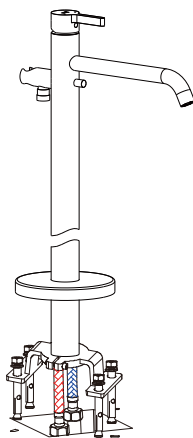

6

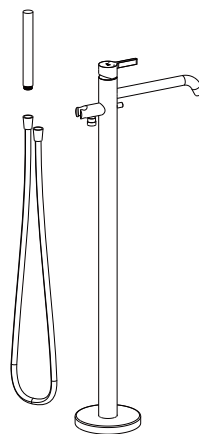

méthode d'utilisation

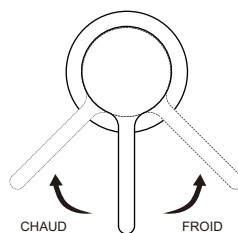
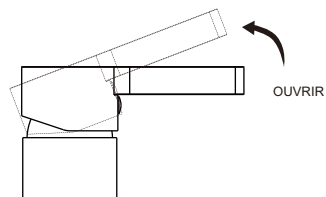

Conditions d'utilisation

1. Pression d'alimentation en eau froide/eau chaude : 0,05-1,0Mpa (0,5-10Kgf/cm).
2. La température ambiante doit être supérieure à 0°C.
3. Température d'alimentation en eau $\leq 90^{\circ}\text{C}$.
4. Le couple au niveau de l'écrou de connexion ne peut pas être supérieur à 10 Nm

TOTS Design decline toute responsabilité en cas de non-respect de ces instructions.
Any failure to follow these instructions releases TOTS Design from any liability